

Schnitt B-B

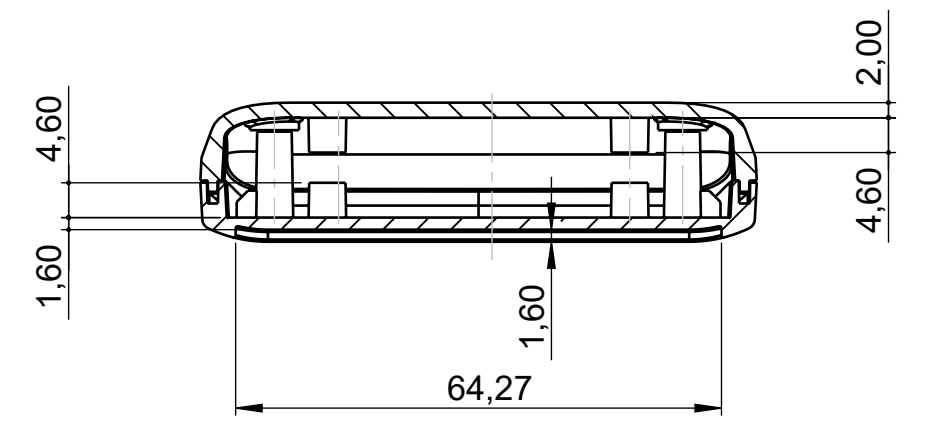

Klebefolie
Adhesive Foil

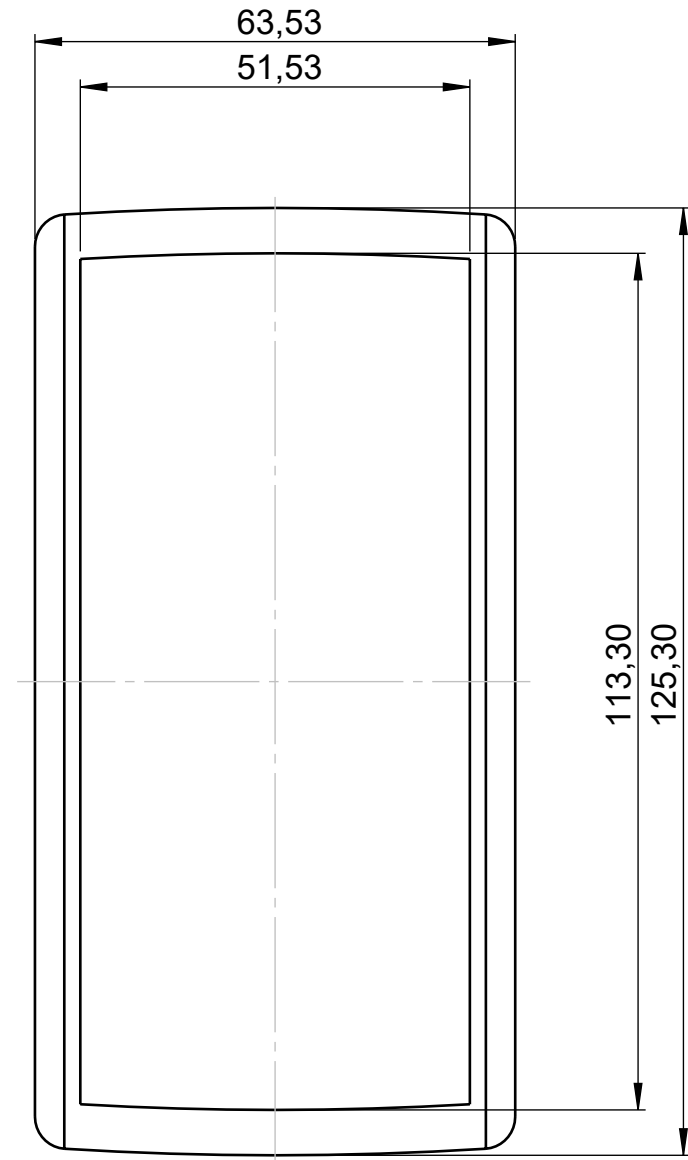

Unterteil
Bottom Part

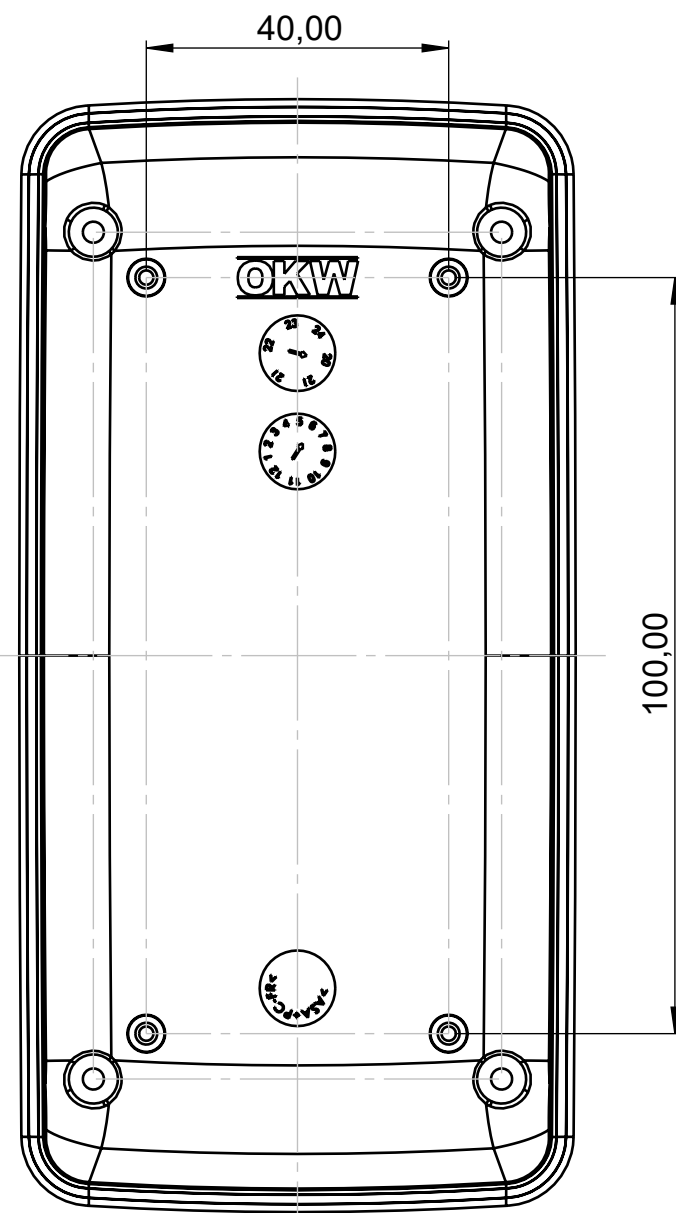

Platine Oberteil
P C B Top Part

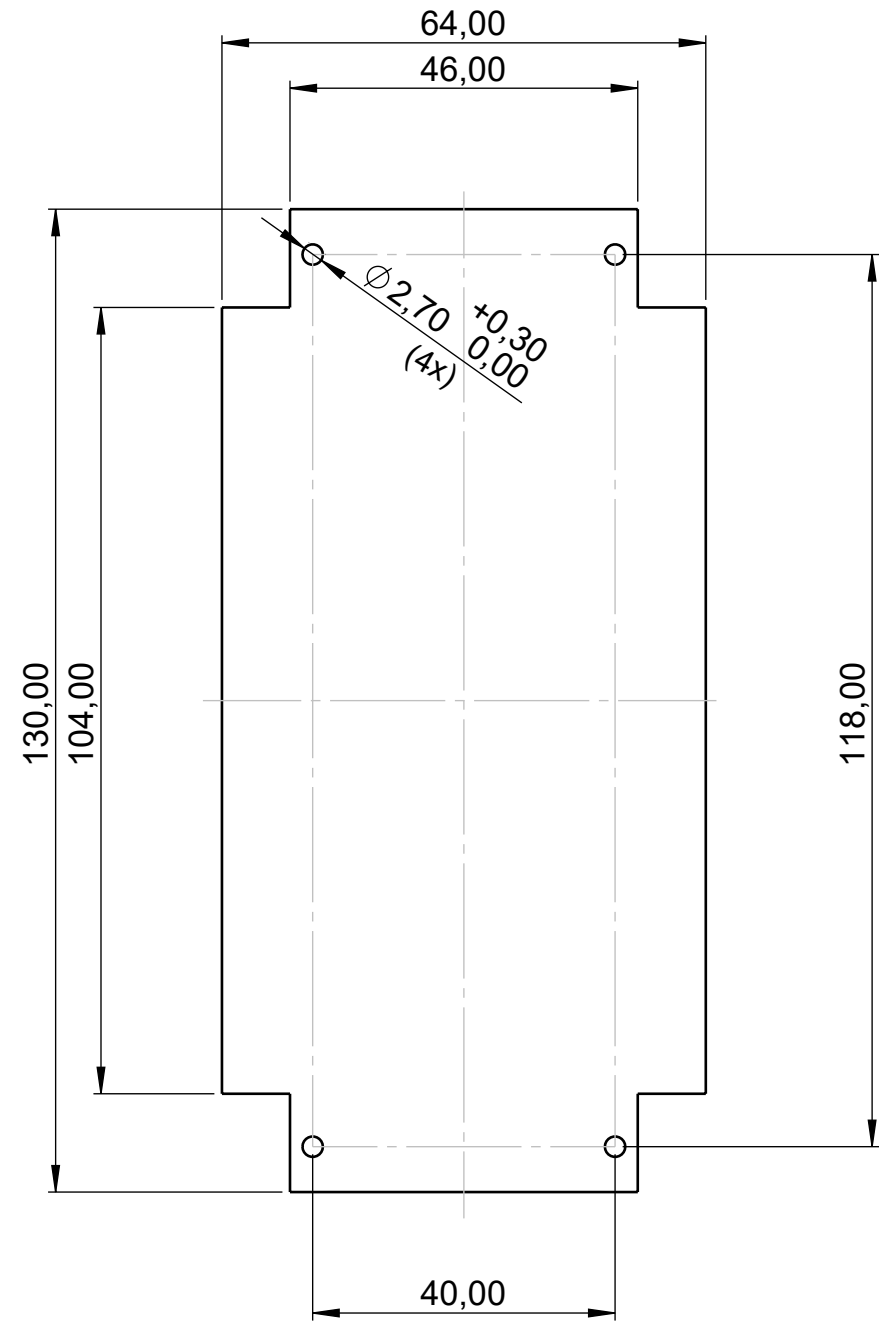

Platine Unterteil
P C B Bottom Part

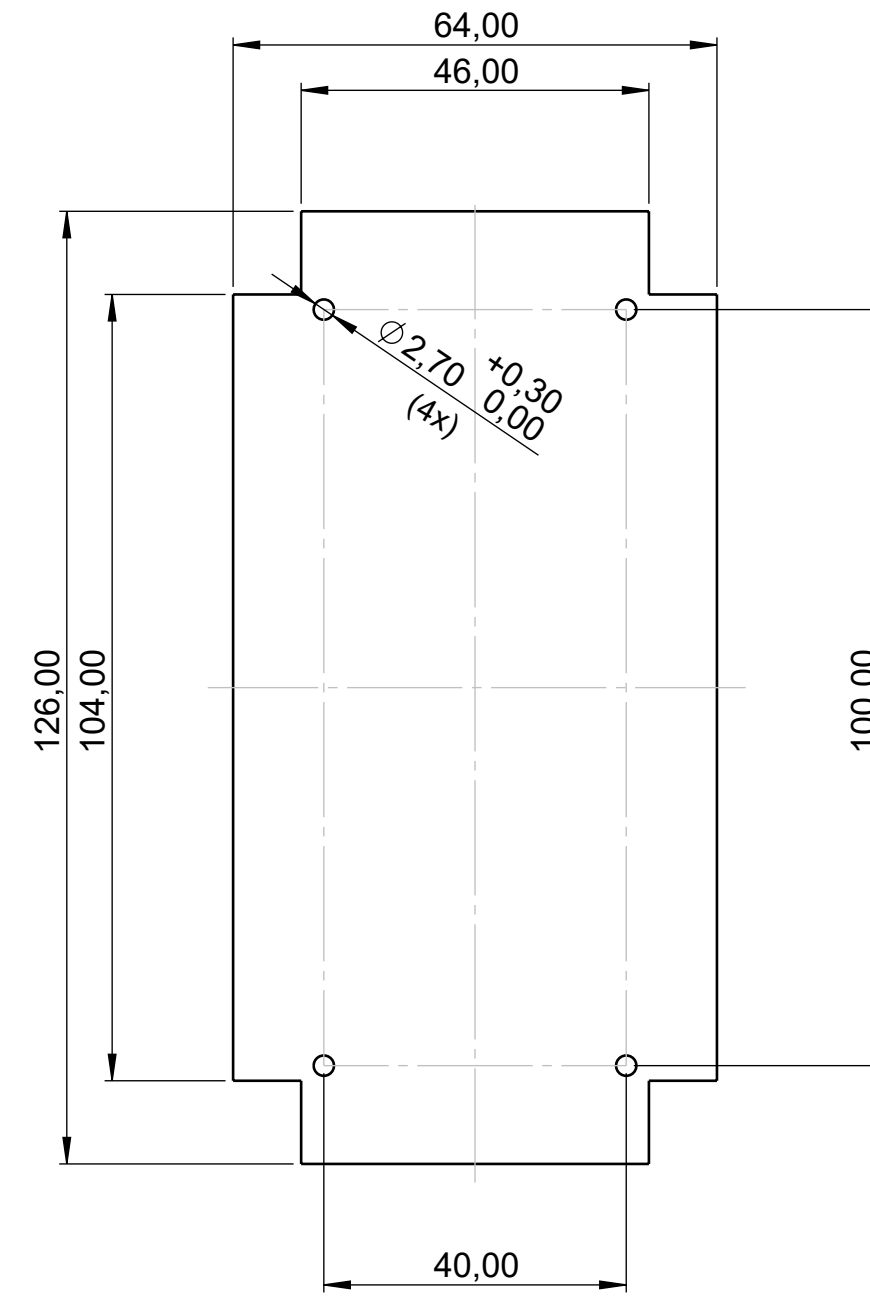

Frontscheibe
Front Panel
(B5503201)

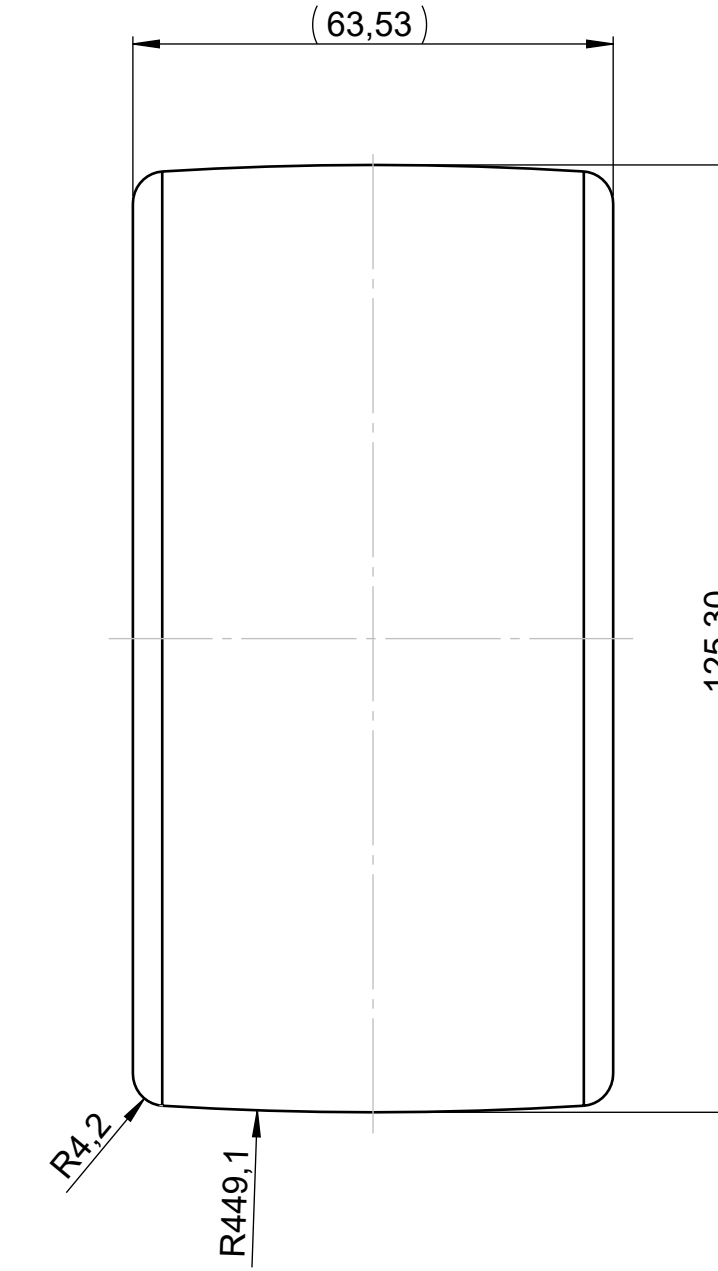

Folientastatur
Membrane Keyboard

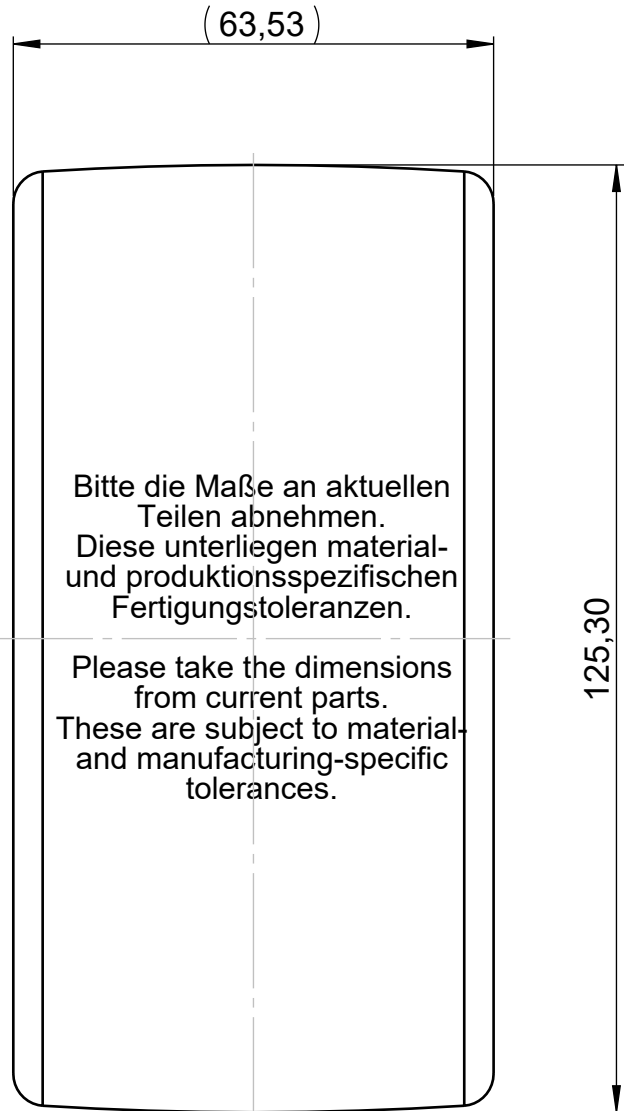

Bitte die Maße an aktuellen
Teilen abnehmen.
Diese unterliegen material-
und produktionspezifischen
Fertigungstoleranzen.
Please take the dimensions
from current parts.
These are subject to material-
and manufacturing-specific
tolerances.

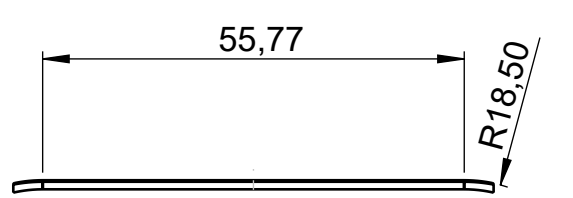
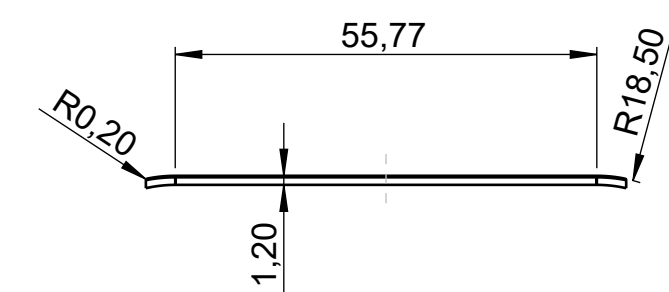
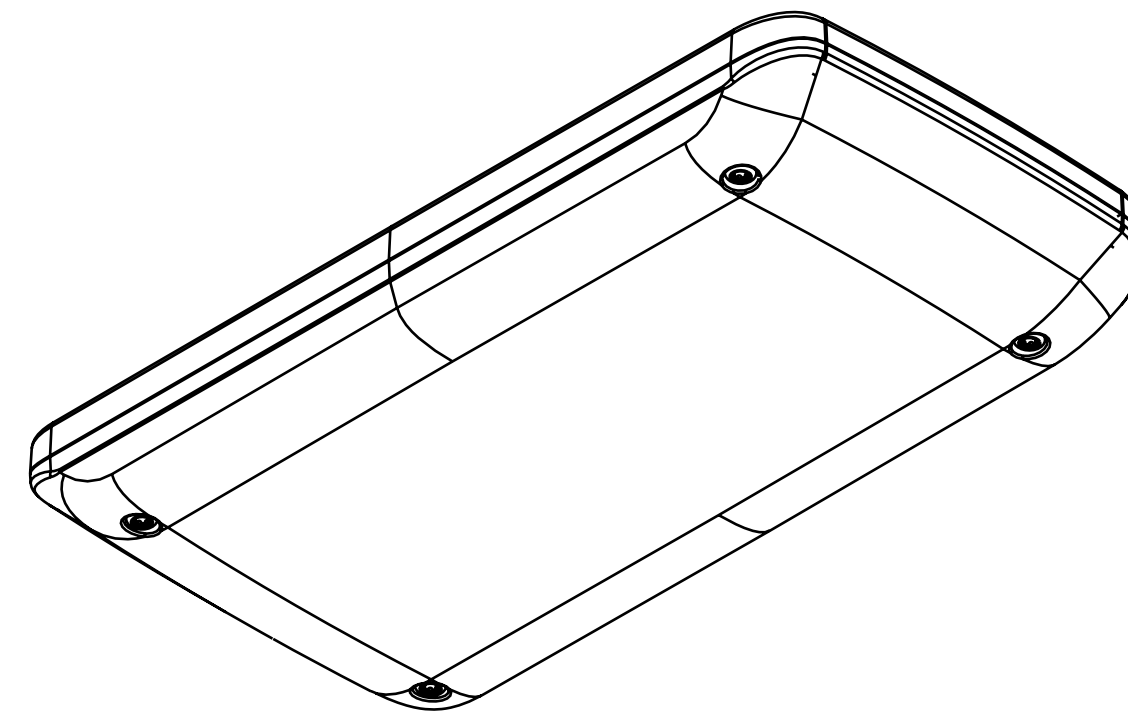
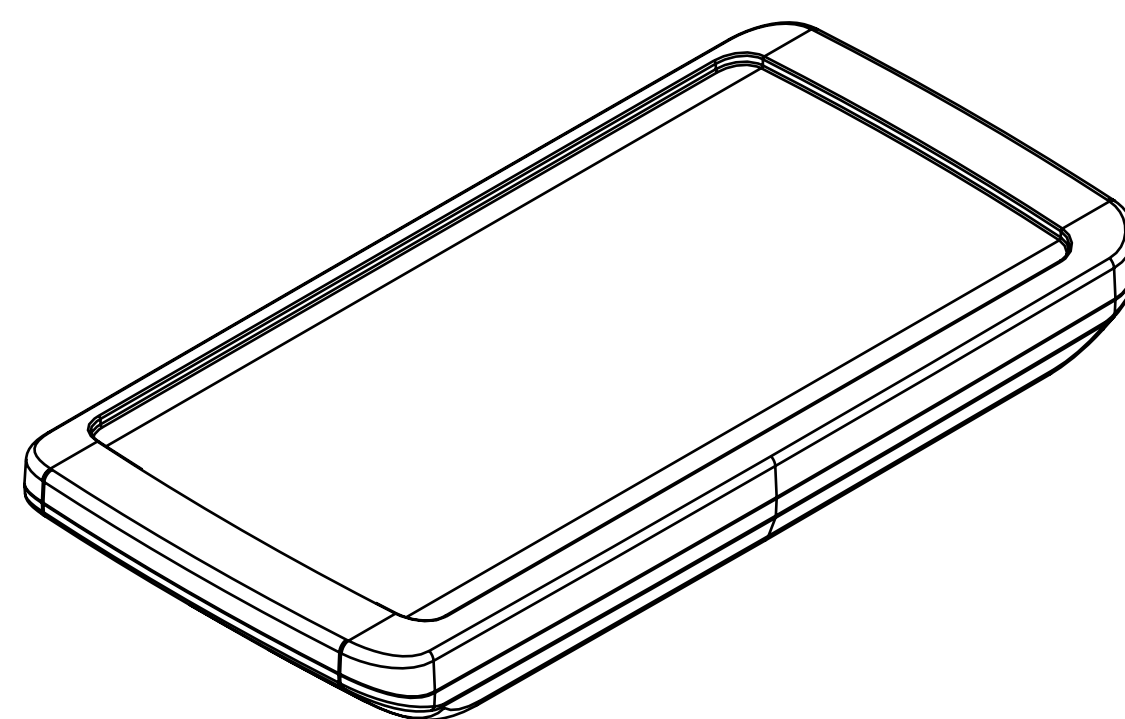

Bitte die Maße an aktuellen
Teilen abnehmen.
Diese unterliegen material-
und produktionspezifischen
Fertigungstoleranzen.
Please take the dimensions
from current parts.
These are subject to material-
and manufacturing-specific
tolerances.

Informationskopie
Copy for Information
will not be updated

Erst. am: 18.03.2020
Erst. von: O. Herrlich
Freig. am: 27.10.2023
Freig. von: J. Wiesbächer
Revision: 02

Toleranzen: DIN ISO 20457 TG 6
Status: SERIENFREIGABE
Zeichnungsart: KUNDE
Volumen: 01
DIN 6 Teil 2



This document contains proprietary information of OKW Gehäusesysteme GmbH and is rendered subject to the conditions that the information be retained in confidence and not be reproduced or copied and not be used or incorporated in any product.
SLIM-CASE M
Ausführung III
B5403300
M 1:1
Für dieses Dokument behalten wir uns alle Urheberrechte vor. Es darf auch auszugsweise weder vervielfältigt noch Dritten in irgendeiner Form zugänglich gemacht werden.
Dateiname: 00027108